

75" Ultra High Brightness Window Displays



Designed for outward-facing window displays in direct sunlight

3,500cd/m² Direct Sunlight Readable











Designed for shopfront windows, these displays feature commercial grade ultra-high brightness panels (3,500cd/m²) that are up to 10 times brighter than domestic televisions. This ensures that content really stands out, even the brightest direct sunlight.



450cd/m²



3,500cd/m²

-  Sleek Thin Bezel
-  Smart Temperature Control
-  Lightweight Enclosure
-  Landscape or Portrait
-  Integrated Android Media Player
-  24/7 Commercial Grade
-  External Light Sensor
-  Polarised Lens Viewable
-  3-Year Warranty
-  Lifetime Technical Support

Ultra Resistant to Blackening Defect (up to 110°C)

Thanks to their special ultra-high brightness panels, these displays can withstand surface temperatures up to 110°C without suffering from any blackening defect. This is crucial for outward-facing window displays, which must contend with exposure to direct sunlight.



110°C



80°C

Optional Hanging Ceiling Mount Available

A height adjustable hanging ceiling mount is available that allows perfect positioning of the Ultra High Brightness Window Displays. Works both in portrait and landscape orientation and is compatible with all screens in this range.



Other Features

Smart Temperature Control System

The responsive internal airflow system keeps the panel and other internal components at optimum working temperature. This ensures a long and reliable life for your screen, even when used continuously in outward-facing windows.

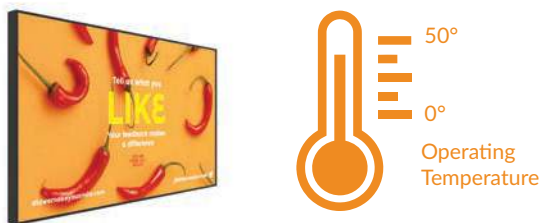

Stylish Lightweight Enclosure

By utilising aluminium for the front frame of the enclosure, these displays have a high thermal conductivity for rapid heat loss and are lightweight for easy installation. This is enhanced by the integrated rear handles, which makes install even easier. The back case is made of robust mild steel for added durability.



Easy Install Handles

With four handles integrated into the rear of the enclosure, these displays are incredibly easy to hold and manoeuvre. This ensures a smooth, hassle-free installation process.



Sleek Thin Bezel

The narrow bezel not only gives these displays a stylish, modern aesthetic, but also means maximum attention is drawn to the on-screen content for high impact messaging.



Ambient Light Sensor

These displays include an external ambient light sensor for use when required. This ensures the screen is always operating at the most suitable brightness for its environment. The external nature of this sensor also enables seamless kiosk integration.



24/7 Commercial Use

With a commercial grade LCD panel, LED backlight and internal components, these displays have the ability to be in constant use 24/7 for over 70,000 hours. They also have no external buttons or controls to avoid tampering.



Integrated Android Media Player

The integrated Android media player allows you to easily update on-screen content via USB plug and play. Alternatively, upgrade your screen to be networked without needing any additional hardware to unlock our cloud-based CMS software. Third-party software can be installed instead if required.



Viewable Through Polarised Lenses

Unlike standard LCD panels, which appear very dark or even completely black if viewed while wearing polarised glasses, these specialised displays remain completely visible. This gives total confidence that no one will miss your messages.



Key Features



3,500CD/M2 SUNLIGHT READABLE



SMART TEMPERATURE CONTROL



LIGHTWEIGHT ENCLOSURE



24/7 IPS PANEL



SUPER HIGH CONTRAST RATIO



POWER TIMER



USB PLUG AND PLAY



OPTIONAL NETWORK UPGRADE



ULTRA RESISTANT TO BLACKENING DEFECT

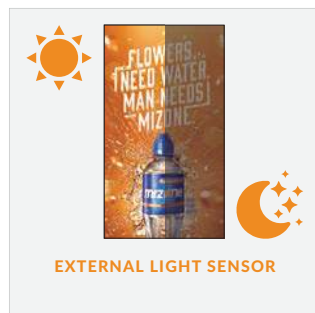

EXTERNAL LIGHT SENSOR

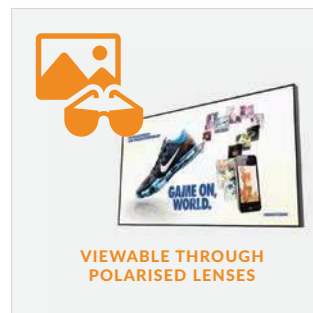

VIEWABLE THROUGH POLARISED LENSES

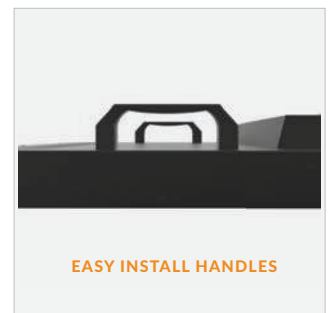

EASY INSTALL HANDLES

Specification Table

		75 Inch
Panel	Resolution	3840x2160*
	Bezel Size (mm)	18
	Display Area (mm)	1649.7x927.9
	Aspect Ratio	16:9
	Brightness (cd/m ²)	3,500
	Colour	16.7M
	Viewing Angle	178°
	Contrast Ratio	1,100:1
	Blackening Defect Free	Up to 110°C (230°F)
AV Inputs	Video	HDMI, VGA
	Audio	Audio Socket (3.5mm)
Power	Average Power Consumption (W) At Maximum Brightness	580
	Input Voltage	AC110~240V (50Hz~60Hz) (Manual switching necessary)
Mechanical	Unit Size (WxHxD mm)	1689.7x968x85
	Package Size (WxHxD mm)	1830x1120x246
	VESA Holes (mm)	400x400
	No. of Handles	4
	Net Weight (kg)	48.5
	Gross Weight (kg)	63.3
Environmental	Surface Panel Temperature	Up to 110°C (230°F)
	Operating Temperature	0°C to 50°C
	Storage Temperature	-30°C to 60°C
	Operating Humidity	10% to 80%
	Storage Humidity	5% to 95%
Computer	Media Formats	Video (MPG, AVI, MP4, RM, RMVB, TS), Audio (MP3, WMA), Image (JPG, GIF, BMP, PNG)
	Media Resolution	1920x1080/1080x1920
	CPU	Quad-Core ARM Cortex A17, 1.6GHz
	GPU	Quad-Core ARM Mali-T764
	RAM	DDR3 2GB
	Internal Storage	8GB eMMC
	USB	1 x USB (OTG/HOST), 1 x USB (HOST)
	LAN	100M/1000M Ethernet (Network Version Only)
	Wi-Fi	802.11b/g/n (Network Version Only)
	OS	Android 7.1
	Graphic Engine	OpenGL ES 1.1/2.0/3.0/3.1, OpenCL 1.1, Renderscript, Direct3D 11.1
Accessories	Included	Scheduling Software, Remote Control, User Manual
	Optional	Network Upgrade, Wall Mount, Floor Stand/Trolley, Ceiling Mount, Table Stand
Warranty	Warranty Period	3 Year Warranty
	Technical Support	Lifetime

Errors and omissions excepted



*Modification Required to Display 4K Resolution

Technical Drawing

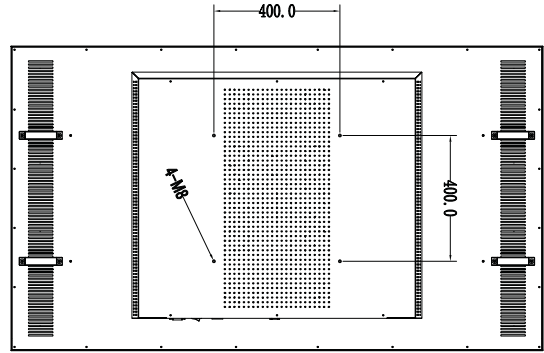
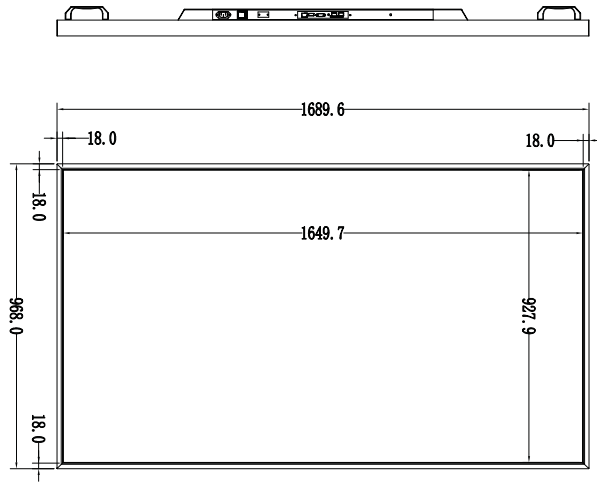

Why Choose Our Commercial Display Solutions?



Lifetime Technical Support

From the moment you receive your product, throughout the duration of your warranty and even after your warranty has expired we are here to support you. If you require any assistance setting up or using your product, or have any problems at all, we can provide free technical support via telephone and email.

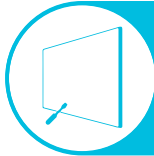

On-site Support and Maintenance*

If needed, we can provide an installation service for any of our products. We can also set up service-level agreements for larger projects that require maintenance contracts.



Extended Warranty*

All of our commercial display products come with a 3 year commercial warranty as standard but if you want to extend this you can upgrade this to cover a 5 year period at point of purchase.



Training

As well as providing free remote CMS training sessions and webinars we can also visit you to deliver bespoke training for our software and hardware*.



Advanced Replacements†

Should your display suffer from any kind of hardware failure during the warranty period we will send you an advanced replacement and arrange for your old display to be collected, free of charge. This ensures no downtime where you are without a screen.



Custom Product Testing & Configuration

If you need us to test third party software or a website, or configure your screen in a particular way before it is dispatched (e.g. in a particular orientation or network mode), we can do so to make your life easier.



3D Rendering

Want to know how a particular screen will look once installed? Send us a photo of the location and we will create a 3D rendering of any screen in situ to help you to visualise how amazing it will look.



Logistics Support

We hold more stock in our UK warehouse than any other manufacturer so we can help you meet tight deadlines. For last minute orders we can also offer special express or morning delivery options*. We also carry out UK based quality control checks on every display before it leaves our warehouse.



Project Support

If you need to loan a sample unit to test we'd be more than happy to arrange this. We can also provide a rental service for temporary projects*.



Customisation*

Your display can be customised to suit your requirements by adding your logo or printed graphics or even tailoring the colour of a display. We can also carry out hardware modifications to existing products or manufacture bespoke solutions for special projects.



Extras*

As well as being able to provide accessories and add-ons, such as extra remote controls, NUC PCs and video wall controllers, we can also supply custom made flight cases which are great if a display needs to be moved safely from place to place.

†UK mainland only

*These particular services may incur additional charges